











PC-F1A Self tapping female (page 1 of 2)

| | | | | | | | |
|---|--|--|---|--|--|--|--|
|  | USE WITH: | | | INSTALL WITH: | | | |
| | PC-M1B  PC-M2H  | PC-VM1  PC-VMX  | PC-SM2  PC-SM2H  | CT-01  | CT-03  | CT-07  | CT-10  |
| INSTALLATION STEPS <small>(see reverse for more options)</small> | | | | | | | |

1 Drill hole through panel & frame

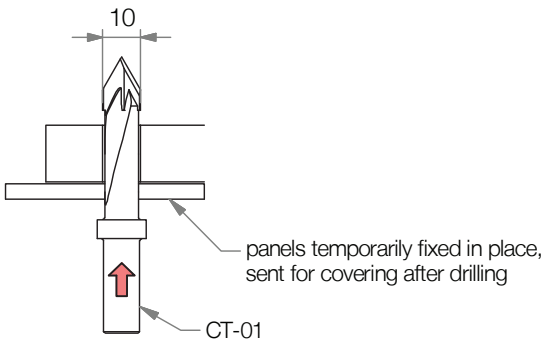

2 Drill out frame hole with CT-07

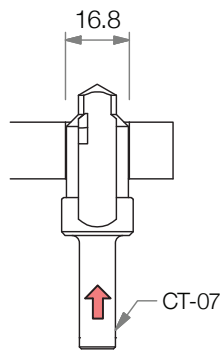

3 Screw fit PC-F1 with CT-03

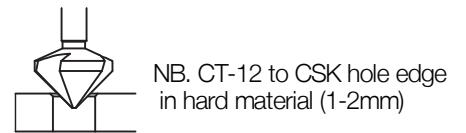
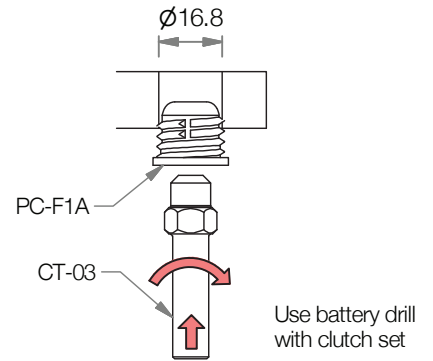

4 Screw fit PC-F1 into thin frame

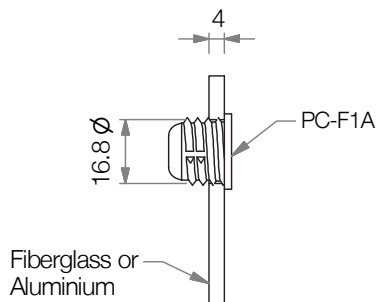





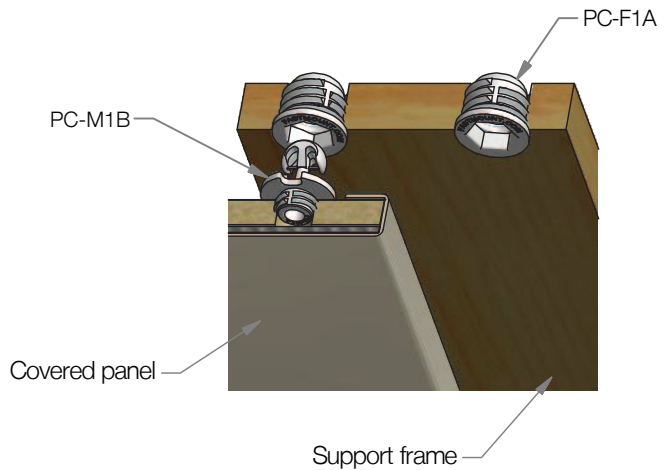



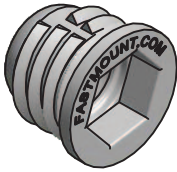

PC-F1A can be used as screw / friction fit into thin frames & seat backs

5 Cutaway view showing panel mounting

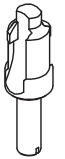

PC-F1A Self tapping female (page 2)

| | | | | | | | | | |
|---|-----------|--|--|--|---------------|---|---|---|---|
|  | USE WITH: | PC-M1B | PC-VM1 | PC-SM2 | INSTALL WITH: | CP-01A | CT-07 | CT-09 | CT-10 |
| | |   |   |   | |  or CP01ST |  |  |  |
| INSTALLATION STEPS (continued from previous page) | | | | | | | | | |

1 Fit CP-01A into PC-F1A then push panel to mark center

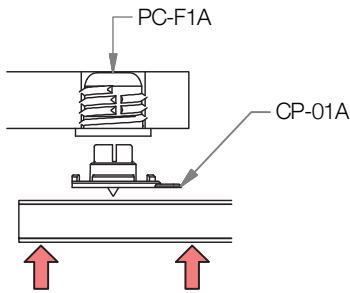

2 Drill panel on center mark with CT-09 7.5mm deep for PC-M2H

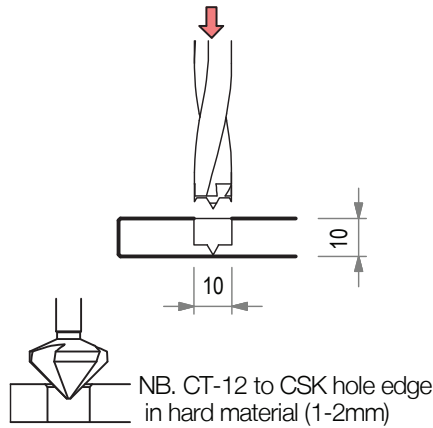

3 Screw fit male clip with CT-10

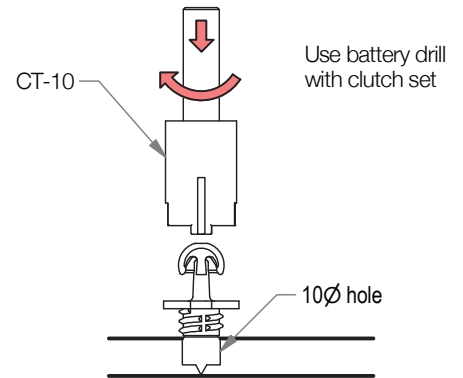

INSTALLING ADHESIVE FIT MALE CLIPS (first complete steps 1 to 3, page 1)

4 Clip PC-SM2 into PC-F1A

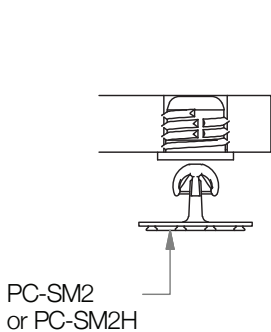

5 Apply adhesive to PC-SM2

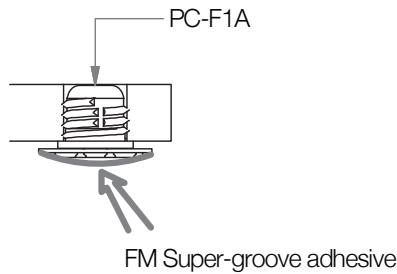

6 Place panel & support while adhesive dries

